

DATASHEET - RE-FIT GRID LUMINAIRES

Plug&Play
Simple mounting with magnetic clips
(average time to convert grid luminaire 8-12 minutes)

Top color rendering
And excellent viewing comfort thanks to **CRI 92**

Sustainability
The existing luminaire housing can remain.
No structural measures on the ceiling required.

Subsidies
The criteria >120lm/W, CRI and ENEC certification are fulfilled

IP54
Protection of the luminaire (Electronic ballast IP20)

Fully certified LED luminaire
in accordance with ENEC standard (CE, ENEC, UL, EN, etc.)
Flawless product situation in terms of standards, liability and warranty.
In contrast, the situation with LED tubes is always critical and contentious in terms of the warranty. For LED tubes, the electrician would have to create a CE label for the retrofitted luminaire.

DATASHEET - RE-FIT GRID LUMINAIRES

RE-FIT SET



YOUR INNOVATIVE SOLUTION

Due to the phase-out of conventional light sources (T5, T8) at the end of August 2023, a solution was developed with which existing grid luminaires can be converted and used further.

We offer Re-Fit Sets with the latest LED technology and guarantee simple and safe handling.

Your benefits at a glance:

- High efficiency lighting solution up to 180 lm/W
- Energy savings up to 70% compared to a fluorescent tube
- Energy savings up to 30% compared to an LED tube
- Directed light without further losses (symmetrical 120° beam angle)
- Ongoing use of the existing luminaire housing - no structural modifications required
- Fully certified luminaires (CE, ENEC, UL, etc.)
- Excellent light quality with CRI 92
- Flicker-free illumination
- Plug&Play solution - contains luminaire(s), operating unit, cabling and magnetic holders
- "Made in Europe" - in accordance with relevant environmental and sustainability regulations (carbon footprint)
- Eligible for funding > 120 lm/W, CRI >80 and ENEC certification fulfilled
- DALI on request

DATASHEET - RE-FIT GRID LUMINAIRES

TECHNICAL DATA | ORDERING INFORMATION - ITEM SOLD AS A SET

Art. No.	Type	Luminaires Length	Luminous flux*	Typically replaces
1 luminaire				
K-RE-FIT-4000001	KIT RE-FIT SET 1x LED562mm 6W 60mA 4000K, konf.BG 18W ON/OFF, 2x 0° Magnetclips	562mm	1x 900lm	T8, 600mm, 18W
K-RE-FIT-4000002	KIT RE-FIT SET 1x LED1170mm 13W 60mA 4000K, konf.BG 18W ON/OFF, 2x 0° Magnetclips	1170mm	1x 1970lm	T8, 1200mm, 36W
K-RE-FIT-4000003	KIT RE-FIT SET 1x LED1450mm 22W 80mA 4000K, konf.BG 35W ON/OFF, 2x 0° Magnetclips	1450mm	1x 3260lm	T8, 1500mm, 58W
K-RE-FIT-4000004	KIT RE-FIT SET 1x LED516mm 6W 60mA 4000K, konf.BG 18W ON/OFF, 2x 0° Magnetclips	516mm	1x 820lm	T5 HE, 550mm, 14W
K-RE-FIT-4000005	KIT RE-FIT SET 1x LED843mm 8W 50mA 4000K, konf.BG 18W ON/OFF, 2x 0° Magnetclips	843mm	1x 1170lm	T5 HE, 850mm, 21W
K-RE-FIT-4000006	KIT RE-FIT SET 1x LED1124mm 13W 60mA 4000K, konf.BG 18W ON/OFF, 2x 0° Magnetclips	1124mm	1x 1890lm	T5 HE, 1150mm, 28W
K-RE-FIT-4000007	KIT RE-FIT SET 1x LED1450mm 13W 50mA 4000K, konf.BG 18W ON/OFF, 2x 0° Magnetclips	1450mm	1x 2060lm	T5 HE, 1450mm, 35W
K-RE-FIT-4000008	KIT RE-FIT SET 1x LED516mm 7W 80mA 4000K, konf.BG 18W ON/OFF, 2x 0° Magnetclips	516mm	1x 1090lm	T5 HO, 550mm, 24W
K-RE-FIT-4000009	KIT RE-FIT SET 1x LED843mm 12W 80mA 4000K, konf.BG 18W ON/OFF, 2x 0° Magnetclips	843mm	1x 1850lm	T5 HO, 850mm, 39W
K-RE-FIT-4000010	KIT RE-FIT SET 1x LED1450mm 18W 70mA 4000K, konf.BG 18W ON/OFF, 2x 0° Magnetclips	1450mm	1x 2740lm	T5 HO, 1450mm, 49W
K-RE-FIT-4000011	KIT RE-FIT SET 1x LED1124mm 21W 100mA 4000K, konf.BG 35W ON/OFF, 2x 0° Magnetclips	1124mm	1x 3040lm	T5 HO, 1150mm, 54W
K-RE-FIT-4000012	KIT RE-FIT SET 1x LED1450mm 28W 100mA 4000K, konf.BG 35W ON/OFF, 2x 0° Magnetclips	1450mm	1x 3970lm	T5 HO, 1450mm, 80W
K-RE-FIT-4000013	KIT RE-FIT SET 1x LED516mm 6W 60mA 4000K, konf.BG 18W ON/OFF, 2x 0° Magnetclips	516mm	1x 820lm	T5 HE ECO, 550mm, 13W
K-RE-FIT-4000014	KIT RE-FIT SET 1x LED1124mm 13W 60mA 4000K, konf.BG 18W ON/OFF, 2x 0° Magnetclips	1124mm	1x 1890lm	T5 HE ECO, 1150mm, 25W
K-RE-FIT-4000015	KIT RE-FIT SET 1x LED1450mm 13W 50mA 4000K, konf.BG 18W ON/OFF, 2x 0° Magnetclips	1450mm	1x 2060lm	T5 HE ECO, 1450mm, 32W
K-RE-FIT-4000016	KIT RE-FIT SET 1x LED516mm 7W 80mA 4000K, konf.BG 18W ON/OFF, 2x 0° Magnetclips	516mm	1x 1090lm	T5 HO ECO, 550mm, 20W
K-RE-FIT-4000017	KIT RE-FIT SET 1x LED1450mm 18W 70mA 4000K, konf.BG 18W ON/OFF, 2x 0° Magnetclips	1450mm	1x 2740lm	T5 HO ECO, 1450mm, 45W
K-RE-FIT-4000018	KIT RE-FIT SET 1x LED1124mm 21W 100mA 4000K, konf.BG 35W ON/OFF, 2x 0° Magnetclips	1124mm	1x 3040lm	T5 HO ECO, 1150mm, 50W
K-RE-FIT-4000019	KIT RE-FIT SET 1x LED1450mm 28W 100mA 4000K, konf.BG 35W ON/OFF, 2x 0° Magnetclips	1450mm	1x 3970lm	T5 HO ECO, 1450mm, 73W
2 luminaires				
K-RE-FIT-4000020	KIT RE-FIT SET 2x LED562mm 6W 60mA 4000K, konf.BG 18W ON/OFF, 4x 0° Magnetclips	2x 562mm	2x 900lm	2x T8, 600mm, 18W
K-RE-FIT-4000021	KIT RE-FIT SET 2x LED1170mm 14W 60mA 4000K, konf.BG 35W ON/OFF, 4x 0° Magnetclips	2x 1170mm	2x 1970lm	2x T8, 1200mm, 36W
K-RE-FIT-4000022	KIT RE-FIT SET 2x LED1450mm 21W 80mA 4000K, konf.BG 60W ON/OFF, 4x 0° Magnetclips	2x 1450mm	2x 3260lm	2x T8, 1500mm, 58W
K-RE-FIT-4000023	KIT RE-FIT SET 2x LED516mm 6W 60mA 4000K, konf.BG 18W ON/OFF, 4x 0° Magnetclips	2x 516mm	2x 820lm	2x T5 HE, 550mm, 14W
K-RE-FIT-4000024	KIT RE-FIT SET 2x LED843mm 8W 50mA 4000K, konf.BG 18W ON/OFF, 4x 0° Magnetclips	2x 843mm	2x 1170lm	2x T5 HE, 850mm, 21W
K-RE-FIT-4000025	KIT RE-FIT SET 2x LED1124mm 13W 60mA 4000K, konf.BG 35W ON/OFF, 4x 0° Magnetclips	2x 1124mm	2x 1890lm	2x T5 HE, 1150mm, 28W
K-RE-FIT-4000026	KIT RE-FIT SET 2x LED1450mm 14W 50mA 4000K, konf.BG 35W ON/OFF, 4x 0° Magnetclips	2x 1450mm	2x 2060lm	2x T5 HE, 1450mm, 35W
K-RE-FIT-4000027	KIT RE-FIT SET 2x LED516mm 7W 80mA 4000K, konf.BG 18W ON/OFF, 4x 0° Magnetclips	2x 516mm	2x 1090lm	2x T5 HO, 550mm, 24W
K-RE-FIT-4000028	KIT RE-FIT SET 2x LED843mm 12W 80mA 4000K, konf.BG 35W ON/OFF, 4x 0° Magnetclips	2x 843mm	2x 1850lm	2x T5 HO, 850mm, 39W
K-RE-FIT-4000029	KIT RE-FIT SET 2x LED1450mm 18W 70mA 4000K, konf.BG 35W ON/OFF, 4x 0° Magnetclips	2x 1450mm	2x 2740lm	2x T5 HO, 1450mm, 49W
K-RE-FIT-4000030	KIT RE-FIT SET 2x LED1124mm 20W 100mA 4000K, konf.BG 60W ON/OFF, 4x 0° Magnetclips	2x 1124mm	2x 3040lm	2x T5 HO, 1150mm, 54W
K-RE-FIT-4000031	KIT RE-FIT SET 2x LED1450mm 26W 100mA 4000K, konf.BG 60W ON/OFF, 4x 0° Magnetclips	2x 1450mm	2x 3970lm	2x T5 HO, 1450mm, 80W
K-RE-FIT-4000032	KIT RE-FIT SET 2x LED516mm 6W 60mA 4000K, konf.BG 18W ON/OFF, 4x 0° Magnetclips	2x 516mm	2x 820lm	2x T5 HE ECO, 550mm, 13W
K-RE-FIT-4000033	KIT RE-FIT SET 2x LED1124mm 13W 60mA 4000K, konf.BG 35W ON/OFF, 4x 0° Magnetclips	2x 1124mm	2x 1890lm	2x T5 HE ECO, 1150mm,
K-RE-FIT-4000034	KIT RE-FIT SET 2x LED1450mm 14W 50mA 4000K, konf.BG 35W ON/OFF, 4x 0° Magnetclips	2x 1450mm	2x 2060lm	2x T5 HE ECO, 1450mm,
K-RE-FIT-4000035	KIT RE-FIT SET 2x LED516mm 7W 80mA 4000K, konf.BG 18W ON/OFF, 4x 0° Magnetclips	2x 516mm	2x 1090lm	2x T5 HO ECO, 550mm, 20W
K-RE-FIT-4000036	KIT RE-FIT SET 2x LED1450mm 18W 70mA 4000K, konf.BG 35W ON/OFF, 4x 0° Magnetclips	2x 1450mm	2x 2740lm	2x T5 HO ECO, 1450mm,
K-RE-FIT-4000037	KIT RE-FIT SET 2x LED1124mm 20W 100mA 4000K, konf.BG 60W ON/OFF, 4x 0° Magnetclips	2x 1124mm	2x 3040lm	2x T5 HO ECO, 1150mm,
K-RE-FIT-4000038	KIT RE-FIT SET 2x LED1450mm 26W 100mA 4000K, konf.BG 60W ON/OFF, 4x 0° Magnetclips	2x 1450mm	2x 3970lm	2x T5 HO ECO, 1450mm,

DATASHEET - RE-FIT GRID LUMINAIRES

TECHNICAL DATA | ORDERING INFORMATION - ITEM SOLD S A SET

Item no.	Type	Luminaires Length	Luminous flux*	Typically replaces
3 luminaires				
K-RE-FIT-4000039	KIT RE-FIT SET 3x LED562mm 6W 60mA 4000K, konf.BG 18W ON/OFF, 6x 0° Magnetclips	3x 562mm	3x 900lm	3x T8, 600mm, 18W
K-RE-FIT-4000040	KIT RE-FIT SET 3x LED516mm 6W 60mA 4000K, konf.BG 18W ON/OFF, 6x 0° Magnetclips	3x 516mm	3x 820lm	3x T5 HE, 550mm, 14W
K-RE-FIT-4000041	KIT RE-FIT SET 3x LED516mm 7W 80mA 4000K, konf.BG 35W ON/OFF, 6x 0° Magnetclips	3x 516mm	3x 1090lm	3x T5 HO, 550mm, 24W
K-RE-FIT-4000042	KIT RE-FIT SET 3x LED516mm 6W 60mA 4000K, konf.BG 18W ON/OFF, 6x 0° Magnetclips	3x 516mm	3x 820lm	3x T5 HE ECO, 550mm, 13W
K-RE-FIT-4000043	KIT RE-FIT SET 3x LED516mm 7W 80mA 4000K, konf.BG 35W ON/OFF, 6x 0° Magnetclips	3x 516mm	3x 1090lm	3x T5 HO ECO, 550mm, 20W
4 luminaires				
K-RE-FIT-4000044	KIT RE-FIT SET 4x LED562mm 6W 60mA 4000K, konf.BG 35W ON/OFF, 8x 0° Magnetclips	4x 562mm	4x 900lm	4x T8, 600mm, 18W
K-RE-FIT-4000045	KIT RE-FIT SET 4x LED516mm 6W 60mA 4000K, konf.BG 35W ON/OFF, 8x 0° Magnetclips	4x 516mm	4x 820lm	4x T5 HE, 550mm, 14W
K-RE-FIT-4000046	KIT RE-FIT SET 4x LED516mm 7W 80mA 4000K, konf.BG 35W ON/OFF, 8x 0° Magnetclips	4x 516mm	4x 1090lm	4x T5 HO, 550mm, 24W
K-RE-FIT-4000047	KIT RE-FIT SET 4x LED516mm 6W 60mA 4000K, konf.BG 35W ON/OFF, 8x 0° Magnetclips	4x 516mm	4x 820lm	4x T5 HE ECO, 550mm, 13W
K-RE-FIT-4000048	KIT RE-FIT SET 4x LED516mm 7W 80mA 4000K, konf.BG 35W ON/OFF, 8x 0° Magnetclips	4x 516mm	4x 1090lm	4x T5 HO ECO, 550mm, 20W

- *Measurement with laboratory power supply
- All typical values for Ta=25°C +/- 2°C
- Luminous flux min. value = typ. value - 20%
- Tolerance mechanical dimensions +/- 1mm
- Tolerance electrical data +/- 15%
- Tolerance optical data +/- 15%
- Tolerance min. value CRI +1/-1
- Energy efficiency class (valid for light source): up to 80mA=C, from 100mA=D

OTHER LIGHT COLORS AVAILABLE ON REQUEST:

Code	DL	CW	WW	PC
Color	Daylight	Cool White	Warm White	Pasta & Cheese
CCT	6500K	5000K	3000K	2700K



DATASHEET - RE-FIT GRID LUMINAIRES

CONVERTER (ON/OFF) INCL. FEEDER CABLE



- On/Off operation
- Driver dimensions 18W: 127 x 43 x 30mm
- Driver dimensions 35W: 142 x 43 x 30mm
- Driver dimensions 60W: 225 x 43 x 30mm
- Driver dimensions 100W: 295 x 43 x 30mm
- DALI on request
- Magnetic mounting on request
- "Built-in" driver on request

ORDERING INFORMATION

Type	Item no.
CONVERTER 18W incl. 1x Feeder straight CINCH 530mm	89601388
CONVERTER 35W incl. 1x Feeder straight CINCH 530mm	89601373
CONVERTER 60W incl. 2x Feeder straight CINCH 530mm	89601372
CONVERTER 100W incl. 2x Feeder straight CINCH 530mm	89601389

FEEDER CABLE (INDIVIDUAL ITEM)



- Power supply cable for connecting a linear LED luminaire with cinch to a driver
- The power supply cable is already connected to the driver

ORDERING INFORMATION

Length	Weight	Type	Item no.
530mm	30g	LED Feeder angled CINCH 530	89601612

BRIDGE CABLE



- Bridge to connect two luminaires with Cinch

ORDERING INFORMATION - Bridge

Length	Weight	Type	Item no.
200mm	9g	LED Bridge angled CINCH 200	89601625

DATASHEET - RE-FIT GRID LUMINAIRES

LUMINAIRE



LUMINAIRE DESCRIPTION

- Suitable for the retrofitting of fluorescent tubes or LED tubes
- Ready-to-connect solution available, thanks to Cinch Connection System
- High operational performance due to directional lighting & integrated heat dissipation
- Excellent product illumination thanks to the combination of SMD LEDs and innovative optics
- Safe-use operation due to safety extra-low voltage (SELV)
- Simple installation with application of magnetic fixing plates
- Heat sink profile made of extruded aluminum
- LED modules protected against moisture & dust by conformal coating
- End caps made of PBT
- Cover made of PMMA
- Dimming capability

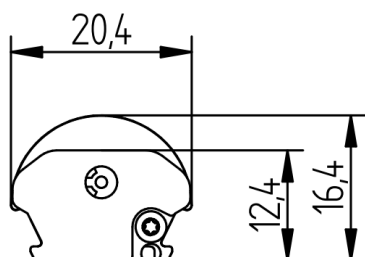

TECHNICAL DATA

Supply voltage	24VDC
Ambient temperature t_a	-30 ... +30 °C
Max. surface temperature profile t_c	60 °C
Type of protection	IP54
Protection class	III
Risk group [EN 62471:2008]	0



LIFETIME

70000h (L80 B10)

STANDARDS

- EN 60598-1
- EN 60598-2-1
- EN 62031
- EN 62471
- EN 60335-1, EN 60335-2-24, EN 60335-2-89
- Eco Design 2019/2020 (SLR)
- Energy Labeling 2019/2015 (ELR)
- PRP/HACCP (Food Safety)
- RoHS/Reach
- ENEC, UL

TEMPERATURE BEHAVIOR

Operating temperature (operation, no defects)	t_a	-30 ... +30 °C
Storage temperature	t_s	-30 ... +60 °C
Temperature cooling profile ¹²	t_c	-30 ... +60 °C

¹ Values apply to operation at 100% output, natural convection.

² If the maximum temperature limits are exceeded, the lifetime of the module will be greatly reduced or the module may be destroyed. The t_c point temperature at the profile of the light engine should be measured in the thermally stable state and under operating conditions by means of a temperature sensor or temperaturesensitive sticker in accordance with EN60598-1. The entire profile can be used as the t_c point.



Note

- Installation should only be conducted by a licensed electrician.
- Reversing the polarity can damage the product!
- Make sure the converter has been switched off prior to connecting the light engine. If this is not observed, the light engine may be damaged!
- Connection or operation is only permitted when using the specified converters. Higher voltages result in damage to or failure of the light engine.
- The user is responsible for correct selection of illumination intensity. Excessive illumination intensity may lead to greying or colour changes of displayed products.
- Lumitech™ accessories must be used. Accessories (e.g. cables) from other manufacturers can lead to failures and damage. The use of these parts will void any warranty claim!
- Luminaires must not be installed next to a cooling or heating outlet!

DATASHEET - RE-FIT GRID LUMINAIRES

PLATE METAL 0° MAGNETIC

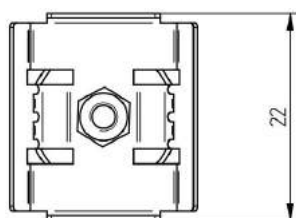
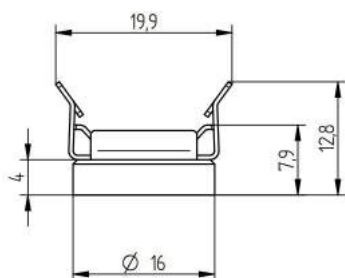

- Mounting holder with 0° angle & magnet
- Material: Metal

TECHNICAL DATA

Ambient temperature in installed condition	-30 ... +80 °C
Ambient temperature during assembly of the luminaire or profile	+10 ... +30 °C
Dimensions L x W x H	22 x 19.9 x 12.8mm
Weight	0.009kg

RoHS

ORDERING INFORMATION

Type	Item no.
LED FIXING PLATE METAL 0° Magnetic	88167382

Packaging: 50 pcs./pack, 1000 pcs./box

AVAILABLE ON REQUEST

PLATE METAL 0°

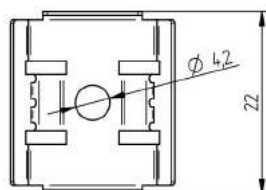
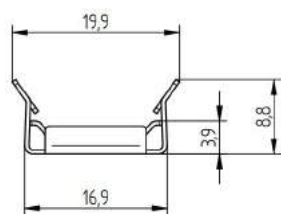
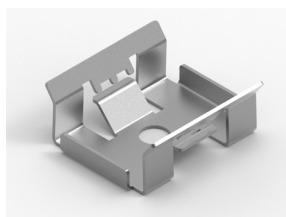

- Mounting holder with 0° angle
- Material: Metal
- Assembly: By means of self-tapping sheet metal screws

TECHNICAL DATA

Ambient temperature in installed condition	-30 ... +80 °C
Ambient temperature during assembly of the luminaire or profile	+10 ... +30 °C
Dimensions L x W x H	22 x 19.9 x 8.8mm
Weight	0.002kg

RoHS

ORDERING INFORMATION

Type	Item no.
LED FIXING PLATE METAL 0°	88167376

Packaging: 50 pcs./pack, 1000 pcs./box

DATASHEET - RE-FIT GRID LUMINAIRES

PLATE METAL ADJUSTABLE MAGNETIC

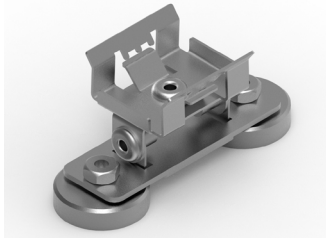

- Magnetic mounting plate
- Material: Metal
- Angle adjustable from -60° to $+60^{\circ}$

TECHNICAL DATA

Ambient temperature in installed condition	-30 ... +80 °C
Ambient temperature during assembly of the luminaire or profile	+10 ... +30 °C
Dimensions L x W x H	49 x 19.9 x 22.8mm
Weight	0.024kg

RoHS

ORDERING INFORMATION

Type	Item no.
LED MAGNETIC PLATE METAL - adjustable	88167385

Packaging: 100 pcs./box

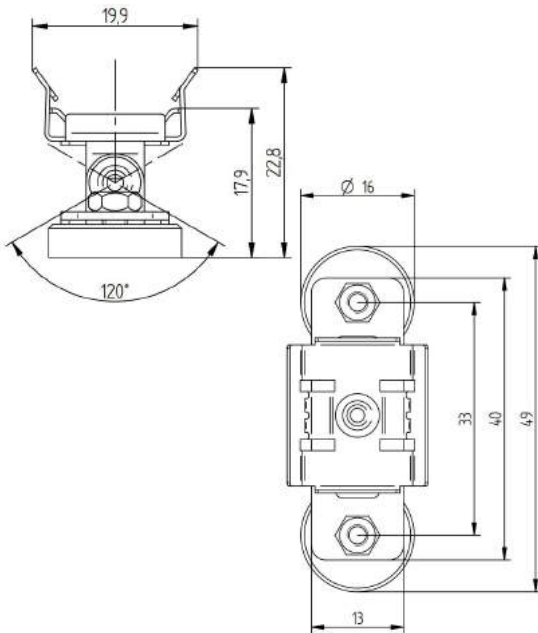

PLATE METAL ADJUSTABLE



- Mounting plate
- Material: Metal
- Angle adjustable from -60° to $+60^{\circ}$

TECHNICAL DATA

Ambient temperature in installed condition	-30 ... +80 °C
Ambient temperature during assembly of the luminaire or profile	+10 ... +30 °C
Dimensions L x W x H	40 x 19 x 19mm
Weight	0.010kg

RoHS

ORDERING INFORMATION

Type	Item no.
LED FIXING PLATE METAL - adjustable	88167384

Packaging: 1000 pcs./box

